

ActiveGT POD Renesas V850ES/Fx3

Ordering code

IC30735



Thank you for purchasing this product from iSYSTEM. This product has been carefully crafted to satisfy your needs. Should any questions arise, do not hesitate to contact your local distributor or iSYSTEM directly. Our technical support personnel will be happy to answer all your technical support questions.

All information, including contact information, is available on our web site www.isystem.com. Feel free also to explore our alternative products.

iSystem constantly yields for development and therefore certain pictures in this documentation may vary slightly from the actual product you received. The differences should be minor, but should you find more serious inconsistencies of the product with the documentation, please contact your local distributor for more information.

This document and all documents accompanying it are copyrighted by iSYSTEM and all rights are reserved. Duplication of these documents is allowed for personal use. For every other case a written consent from iSYSTEM is required.

Copyright © 2011 iSYSTEM, GmbH.
All rights reserved.
All trademarks are property of their respective owners.

Hardware Reference

In-Circuit Emulation PODs

ActiveGT PODs can be used connected to the iC3000 Emulator through the PRO/GT interface iCARD.

A green LED is lit when the ActiveGT POD is powered on.

PIN1 location on every component is also marked on the circuit board with a square block (PIN 1 pin is soldered a square block, other pins have a round pin).

AUX Inputs

The POD has a special interface for an additional ActivePRO/GT AUX card (IC30338), which provides 16 AUX auxiliary inputs. Signals connected to these inputs are either sampled with the trace cycle or on the signal edge change. Inputs are divided into two identical blocks with 8 inputs each. Every block has an adjustable input threshold from 0 to 3V. Inputs are 5V tolerant. For more information see the hardware reference for the ActivePRO/GT AUX Card.

Trigger Output

A trigger output is available on the module. For instance an external logic analyzer can be connected to a coax SMA connector, which provides a 3.3V pulse on a trace trigger event.

Temperature range

All iSYSTEM devices, unless explicitly otherwise noted, are specified to operate at room temperatures (specifically, between 10°C/50°F and 40°C/105°F).

Final Target Application Test

After the application is being more or less debugged and final application test is performed, it is recommended to remove all breakpoints and to close all debug windows (memory, SFR, watch...) to eliminate any possible influence of the emulator on the CPU execution. There were cases where the target application has been behaving differently with the target CPU inserted or the POD connected. If the debugger is configured to update some debug windows in real-time, the user may not be aware of that the CPU execution may be slightly disturbed. However, when the monitor access type is configured to update debug windows while the CPU is running, the CPU execution is disturbed significantly, depending on the necessary number of memory accesses to update opened debug windows.

There are cases when internal peripheral device requires read access of the particular register during the device configuration. The user has had SFR window opened and the necessary read access was actually performed by the debugger and not by the application as it would be correct. Therefore, the application was working fine with the emulator, but a standalone application didn't work correctly, as the peripheral device was not configured properly.

ActiveGT POD Renesas V850ES/Fx3

Ordering code	IC30735
Maximum CPU Frequency	48MHz
Trace Depth	64M Frames
Time Stamp Resolution	33.3ns
Time Reach	Unlimited

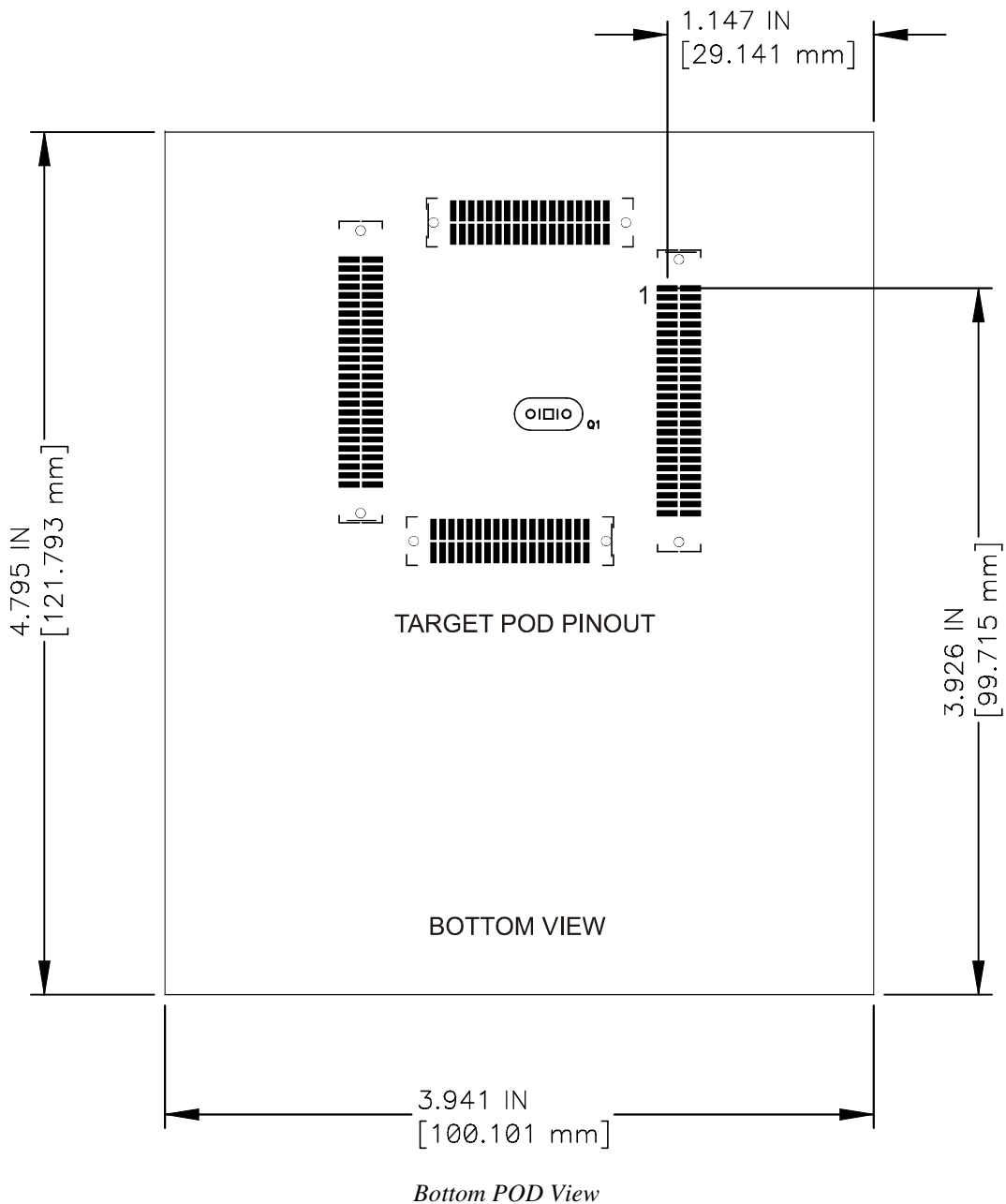

Emulated CPUs	
uPD70F3370-uPD70F3385	uPD70F3610-uPD70F3638

Check with iSYSTEM for the latest list of supported devices. A special emulation device is used in the POD and no CPU needs to be exchanged when emulating any of the supported devices.

Emulation

In-circuit emulation on this POD is done by using a special bondout (EVA) chip from NEC connected to an emulation version of the target chip which performs clock generation and port replacement function.

1Mbyte emulation memory is connected to the bondout emulation bus. This allows downloading the code into the emulation RAM in place of the internal CPU Flash.

External Memory Access

This POD does not support external memory access. It supports single chip target applications only. If external memory access is required, V850ES/Fx3 ActiveGT POD (IC30735) must be used where it's supported.

Electrical Characteristics

Signals connecting the in-circuit emulator and the target system operate, in terms of function, as if an actual device was connected. The characteristics however may be different from those of the actual device.

To be on the safe side, try to withdraw from the electrical limits of the original microcontroller.

Alphanumeric ports connect to Renesas uPD7885.

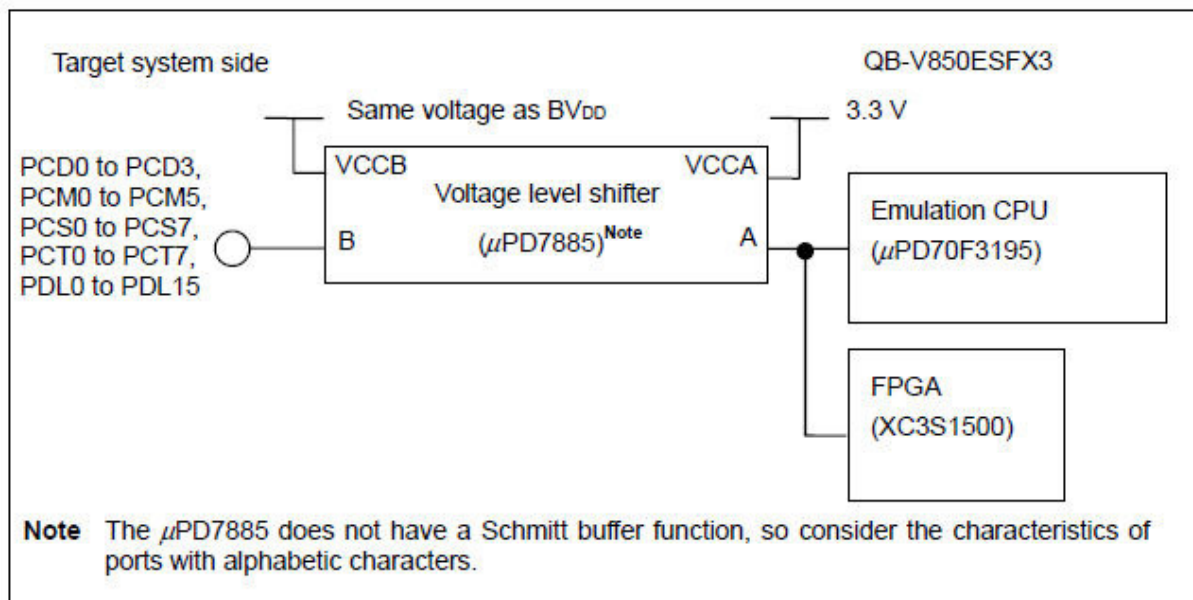

Numeric ports connect to Renesas emulation CPU uPD70F3385.

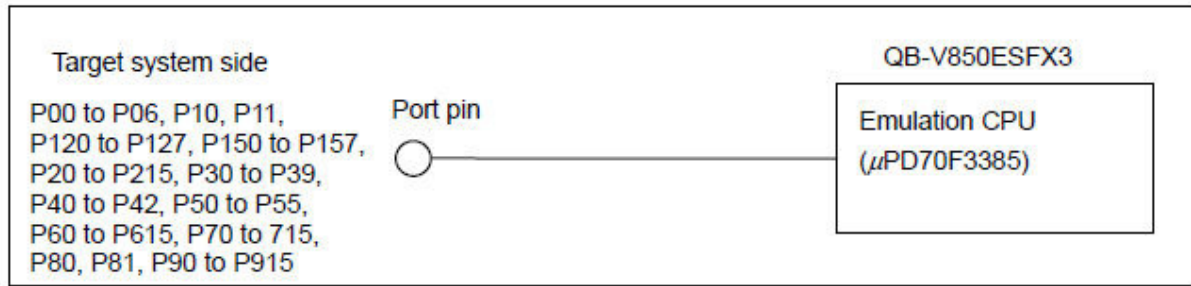

Note: All target port connections are Renesas design. When a detailed electrical characteristics of the in-circuit emulator are required, contact iSYSTEM, which will provide you the necessary Renesas contact.

Clock source

The clock source is selected in the software. When the target or emulator clock is not appropriate, an oscillator can be inserted into Q1 on the bottom of the POD, which is then used as emulator clock when selected as such in the software.

POD Power Supply

The V850ES/Fx3 Active PRO POD auto-detects the power supply by sensing target CPU pins 108 and 127 (QFP176). Each pin has a 10k pull-up connected. While the POD runs in the standalone mode (no target connection), the emulator detects 5V at pin 108 and 127 and then the complete POD is powered with 5V supplied from the emulator.

As soon as the POD is connected to the target or for instance to the adapter only, GND potential will be detected on pin 108 and 127 and the POD will be supplied by the target Vcc, which must be in range 3.3V-5V. When only adapter or a measurement board is connected to the POD, the POD fails to initialize since a power supply from the target is expected but not present in such case.

Current Consumption

The V850ES/Fx3 Active PRO POD has higher current consumption than the real device being emulated. The user should have this in mind when supplying the target with the POD connected instead of the CPU.

Power Supply	Maximum current consumption	Nominal consumption
5V	260mA	160mA
3.3V	160mA	100mA

Maximum current consumption of 260mA must be expected during the download phase. After the download, the current consumption does not exceed 160mA.

The POD initialization and download will most probably fail when the target is not able to provide 260mA at 5V or 160mA at 3.3V power supply.

Target POD Layout

Below two pictures depict top and bottom POD view, which are important to read the target POD pinouts properly.

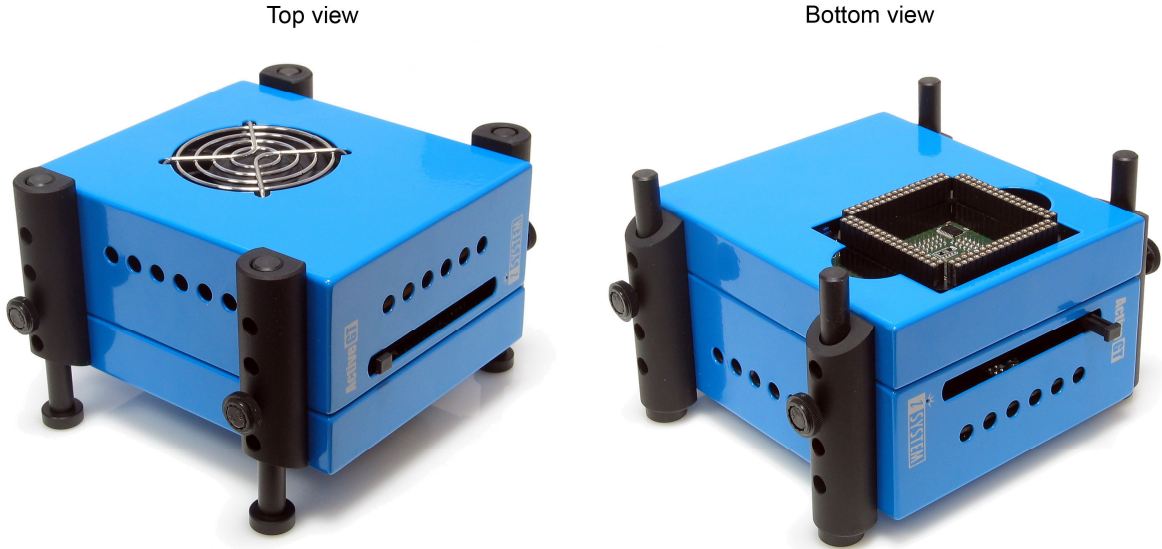

The POD target layout is T_QFP176.

n.c.	176	174	172	170	168	166	164	162	160	158	156	154	152	150	148	146	144	142	n.c.
n.c.	175	173	171	169	167	165	163	161	159	157	155	153	151	149	147	145	143	141	n.c.

n.c.	n.c.	n.c.	n.c.
2	1	139	140
4	3	137	138
6	5	135	136
8	7	133	134
10	9	131	132
12	11	129	130
14	13	127	128
16	15	122	123
18	17	120	121
20	19	118	119
22	21	116	117
24	23	114	115
26	25	112	113
47	28	110	111
30	29	108	109
32	31	106	107
34	33	125	124
36	35	105	126
38	37	103	104
40	39	101	102
42	41	99	100
44	43	97	98
46	45	95	96
48	27	93	94
50	49	91	92
52	51	89	90
n.c.	n.c.	n.c.	n.c.
n.c.	n.c.	n.c.	n.c.

n.c.	53	55	57	59	61	63	65	67	69	71	73	75	77	79	81	83	85	87	n.c.
n.c.	54	56	58	60	62	64	66	68	70	72	74	76	78	80	82	84	86	88	n.c.

T_QFP176 – Top POD view

n.c.	142	144	146	148	150	152	154	156	158	160	162	164	166	168	170	172	174	176	n.c.
n.c.	141	143	145	147	149	151	153	155	157	159	161	163	165	167	169	171	173	175	n.c.

n.c.	n.c.
n.c.	n.c.
140	139
138	137
136	135
134	133
132	131
130	129
128	127
123	122
121	120
119	118
117	116
115	114
113	112
111	110
109	108
107	106
124	125
126	105
104	103
102	101
100	99
98	97
96	95
94	93
92	91
90	89
n.c.	n.c.
n.c.	n.c.

n.c.	n.c.
n.c.	n.c.
1	2
3	4
5	6
7	8
9	10
11	12
13	14
15	16
17	18
19	20
21	22
23	24
25	26
28	47
29	30
31	32
33	34
35	36
37	38
39	40
41	42
43	44
45	46
27	48
49	50
51	52
n.c.	n.c.
n.c.	n.c.

n.c.	87	85	83	81	79	77	75	73	71	69	67	65	63	61	59	57	55	53	n.c.
n.c.	88	86	84	82	80	78	76	74	72	70	68	66	64	62	60	58	56	54	n.c.

T_QFP176 – Bottom POD view

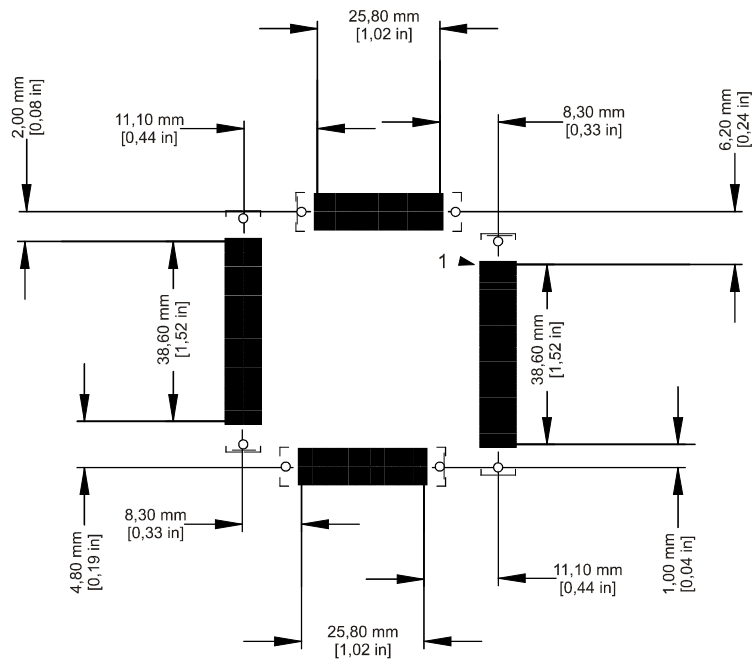

T_QFP176 – Dimensions

The connectors used for target POD pinout are female Tyco Electronics connectors, part number 0-0104652-4 (40 pin) and 0-0104652-6 (60 pin).

Pinout Adapters

An adapter is shipped with the ActivePRO POD which is used to adapt the POD to the T_QFP144 pinout, which must be used when iSystem QFP144 adapters are being used.

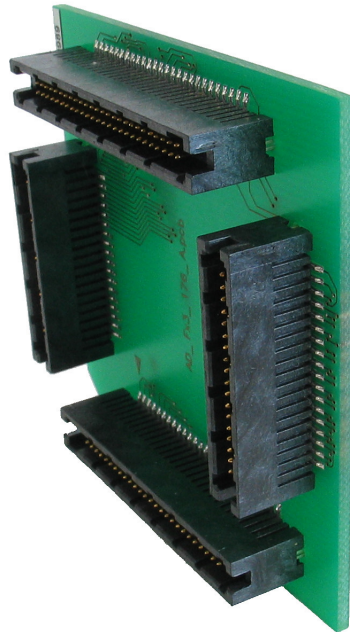

The T_QFP176 to T_QFP144 pinout adapter board

The Adapter Target Layout is T_QFP144.

NC	NC	144	142	140	138	136	134	132	130	128	126	124	122	120	118	116	114	112	110
NC	NC	143	141	139	137	135	133	131	129	127	125	123	121	119	117	115	113	111	109

2	1
4	3
6	5
8	7
10	9
12	11
14	13
16	15
18	17
20	19
22	21
24	23
26	25
28	27
30	29
32	31
34	33
36	35
NC	NC
NC	NC

NC	NC
NC	NC
107	108
105	106
103	104
101	102
99	100
97	98
95	96
93	94
91	92
89	90
87	88
85	86
83	84
81	82
79	80
77	78
75	76
73	74

37	39	41	43	45	47	49	51	53	55	57	59	61	63	65	67	69	71	NC	NC
38	40	42	44	46	48	50	52	54	56	58	60	62	64	66	68	70	72	NC	NC

T_QFP144 – Top POD view

110	112	114	116	118	120	122	124	126	128	130	132	134	136	138	140	142	144	NC	NC
109	111	113	115	117	119	121	123	125	127	129	131	133	135	137	139	141	143	NC	NC

NC	NC
NC	NC
108	107
106	105
104	103
102	101
100	99
98	97
96	95
94	93
92	91
90	89
88	87
86	85
84	83
82	81
80	79
78	77
76	75
74	73

1	2
3	4
5	6
7	8
9	10
11	12
13	14
15	16
17	18
19	20
21	22
23	24
25	26
27	28
29	30
31	32
33	34
35	36
NC	NC
NC	NC

NC	NC	71	69	67	65	63	61	59	57	55	53	51	49	47	45	43	41	39	37
NC	NC	72	70	68	66	64	62	60	58	56	54	52	50	48	46	44	42	40	38

T_QFP144 – Bottom POD view

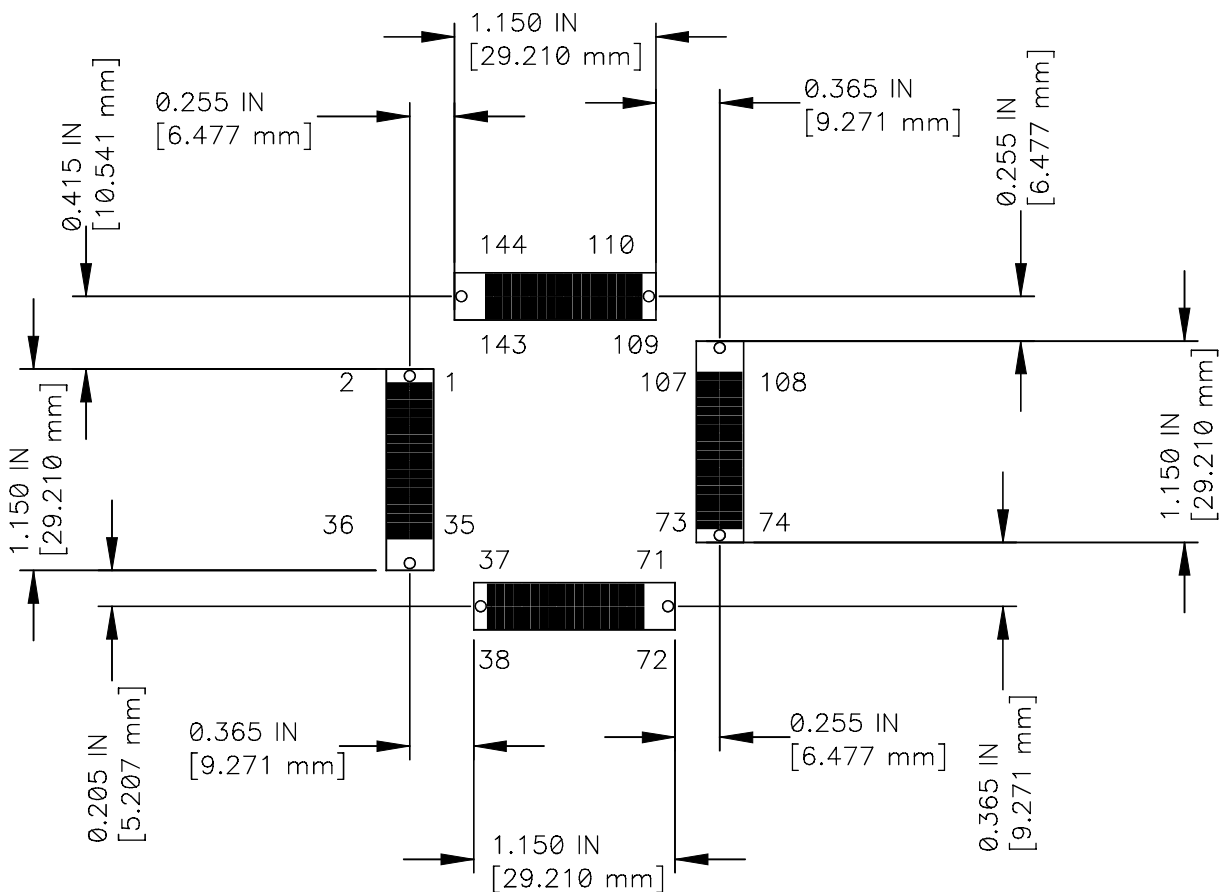

T_QFP144 – Dimensions

The connectors used for target POD pinout are female Tyco Electronics connectors, part number 0-0104652-4 (40 pin).

Target Adapters

iSYSTEM offers various target adapter solutions for this POD. Please refer to the adapter documentation for more details.

Disclaimer: iSYSTEM assumes no responsibility for any errors which may appear in this document, reserves the right to change devices or specifications detailed herein at any time without notice, and does not make any commitment to update the information herein.

© iSYSTEM. All rights reserved.