

---

## Adapters

### MPC5604C Nexus Emulation Adapter 208BGA – 64TQ

Ordering code	IA208BGA64TQ-5604C
---------------	--------------------

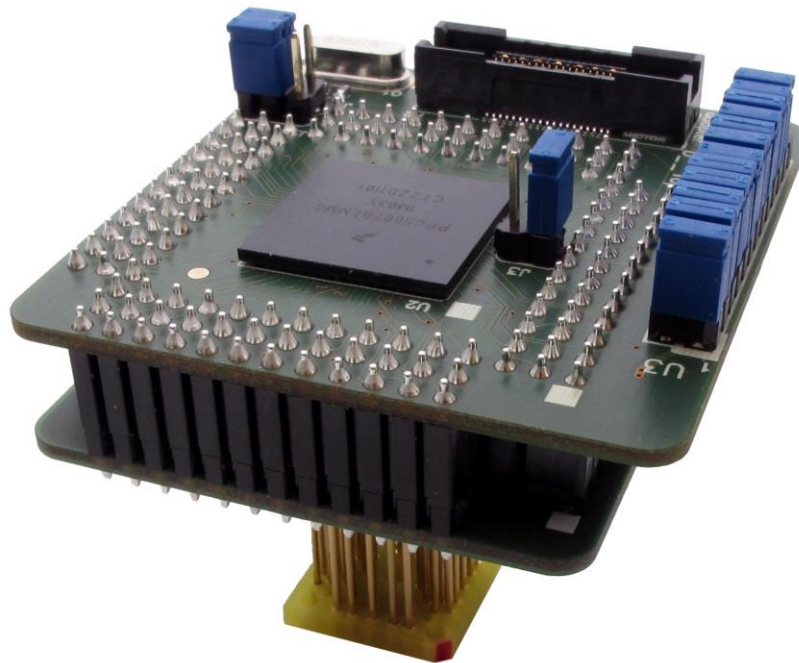

Supported microcontrollers:

- Freescale MPC5602C, MPC5603C and MPC5604C
- ST equivalent devices (SPC560C40, SPC560C50)

Target CPU package: QFP64

Original microcontroller in the QFP64 package has no Nexus port at all which may be a significant drawback during the development and test process.

“Bolero” Nexus Emulation Adapter is based on the MPC5607B microcontroller in the BGA208 package (emulation device), which also exposes 4-bit Nexus port. The Emulation Adapter exhibits the same behaviour to the target as the original 64-pin microcontroller and additionally provides the Nexus port, which allows advanced functionalities like trace, profiler and code coverage.

A 64-pin solder part, which must be ordered separately under the IA64ATQ-SOLDER ordering code, is soldered to the target (PCB) instead of populating the original microcontroller in a 64-pin QFP package. Then the Emulation Adapter, which acts as the original microcontroller and additionally provides debug Nexus port, is connected on top.

Contact iSYSTEM sales representative for more details on available Nexus tools.



## Dimensions

(Unit : mm)	A	B	C	D	E	F	G	H	X	Y
<b>IA208BGA64TQ-5604C</b>	54 x 54	46 x 46	16 x 16	7.5	25	36	47	55	12	1.5

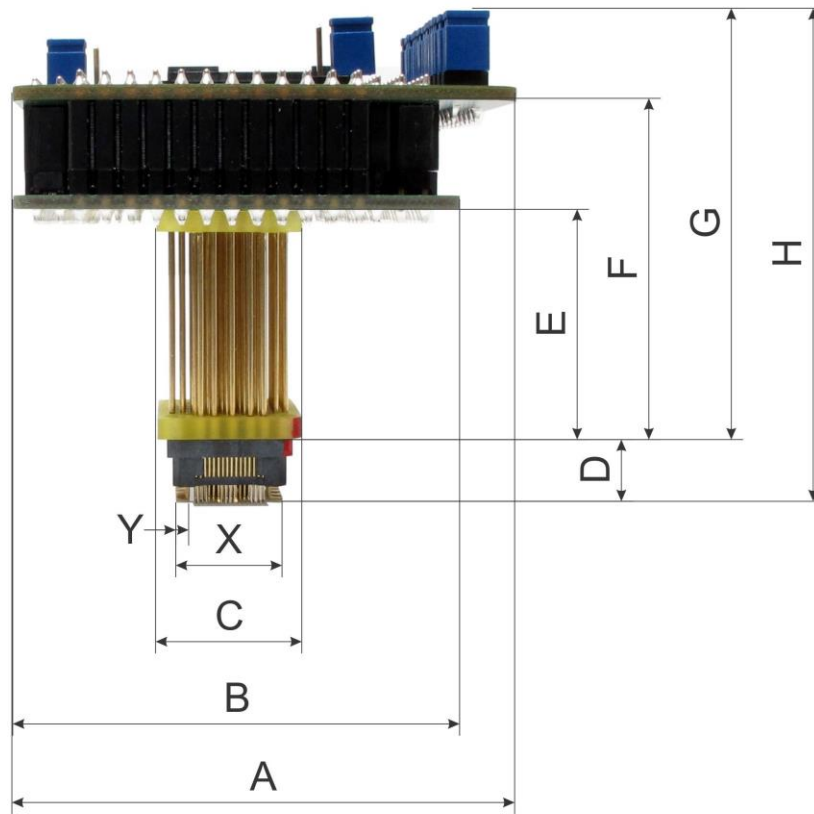

*IA208BGA64TQ-5604C dimensions*

- **IA64ATQ-SOLDER**

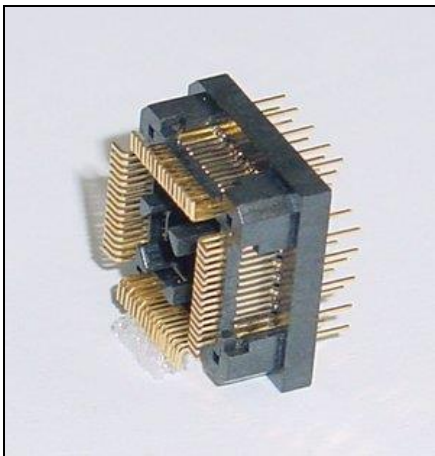

*Solder part, which is being soldered to the target.*

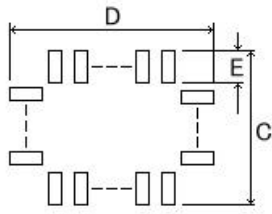

(Unit: mm)						
A	B	C	D	E	K	L
12	1.505	13.0	13.0	2.3	14	14

*Recommended (by TET) PCB footprint size*

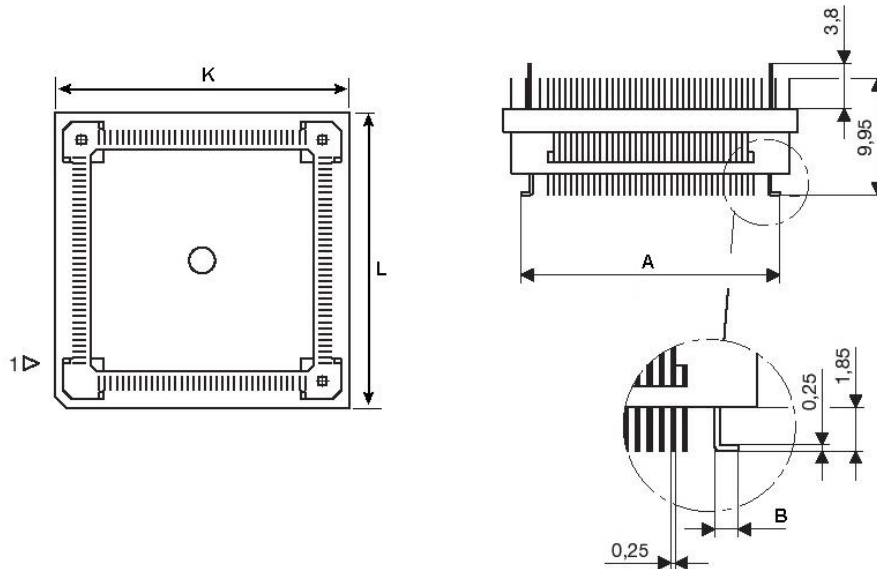

*IA64ATQ-SOLDER dimensions*

User must be familiar with the SMT (Surface Mount Technology) soldering in order to solder the IA64ATQ-SOLDER to the PCB instead of the original microcontroller. On request, iSYSTEM can provide this service too.

## Jumper configuration

### **J1 and J2: clock source configuration**

Jumpers J1 and J2 select clock source for the emulation device. Per default, both jumpers are set to position 1-2, which yields clock source being used from the emulation adapter.

For the first time after receiving the emulation adapter, it is recommended that it's tested with this setting. Once it's confirmed that is operational, target clock use (J1 & J2 position 2-3) can be tested.

Note that the emulation adapter may not operate when crystal circuit is used in the target. Typical design guideline is that a crystal should be as close as possible to the microcontroller. However, it may happen that the target crystal may not oscillate with the emulation adapter since clock lines (XTAL, EXTAL) between the target and the emulation device on the emulation adapter are prolonged. There should be no problem with the oscillator being used in the target.

If an oscillator in the target is not an option and the target crystal doesn't oscillate in conjunction with the emulation adapter, clock from the emulation adapter must be used (J1 & J2 position 1-2). In this case, a crystal circuit must be assembled on the emulation adapter.

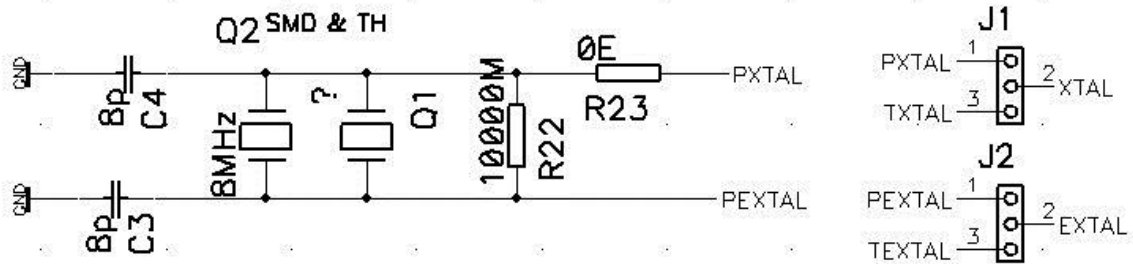

*Crystal circuit*

Note: Above schematic shows two crystals Q1 and Q2. This is only for the PCB design, which is ready for SMT and through-hole crystal. Physically one crystal only is populated.

Crystal circuit is located in the corner of the emulation adapter, next to the Nexus (Mictor) connector.

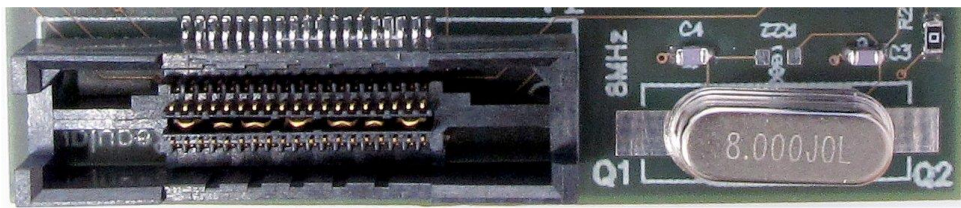

Per default 8pF capacitors are populated for C3 and C4, 0Ω resistor for R23 and 8MHz crystal for Q1. R22 must not be populated. Note that these values are valid for 8MHz crystal only. If different crystal is used, appropriate capacitors and resistor must be soldered (replace original ones).

### **J3: target reset configuration**

Jumper J3 connects the reset line between the emulation device and the target. By default J3 is not populated.

### **U3: power selection**

The U3 header row is used for power supply selection. Power supplies are organized in groups and the same voltage must be supplied for each group.

Refer to the microcontroller user manual for more details which power supply designation belongs to which power supply.

By default all jumpers are set even though only first four jumpers (connecting pins 1-2, 3-4, 5-6, 7-8) affects the configuration. When jumpers are set, target power supply coming from the target gets connected to the microcontroller residing on the emulation adapter. If a different power source is to be used (e.g. in case of a standalone operation), jumpers must be removed and power source must be applied to CVDD\_HV\_ADC1 (pin 2), CVDD\_HV\_ADC0 (pin 4), CVDD\_BV (pin 6), CVDD\_HV (pin 8) and GND (pins 21-26) signals.

Signal direction	Signal	Pin	Pin	Signal	Signal direction
target	TVDD_HV_ADC1	1	2	CVDD_HV_ADC1	CPU
target	TVDD_HV_ADC0	3	4	CVDD_HV_ADC0	CPU
target	TVDD_BV	5	6	CVDD_BV	CPU
target	TVDD_HV	7	8	CVDD_HV	CPU
	NC	9	10	NC	
	NC	11	12	NC	
	NC	13	14	NC	
	NC	15	16	NC	
	NC	17	18	NC	
	NC	19	20	NC	
	GND	21	22	GND	
	GND	23	24	GND	
	GND	25	26	GND	

*U3 signal description*

iSYSTEM power supply adapter can be ordered separately under the IEA-PS ordering code. It connects on top of the emulation adapter directly to the U3 header row and allows standalone usage of the emulation adapter. 3.3V or 5V voltage can be selected for each group with appropriate jumpers J0-J9. This is convenient when the target is not available or it's not adjusted for the emulation adapter connection yet.

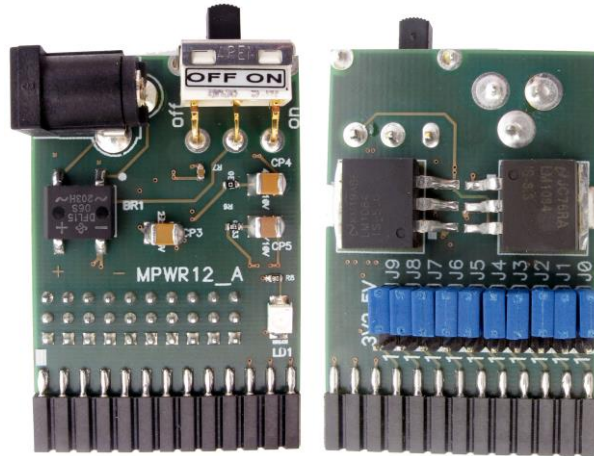

*IEA-PS (optional emulation adapter power supply)*



---

Disclaimer: iSYSTEM assumes no responsibility for any errors which may appear in this document, reserves the right to change devices or specifications detailed herein at any time without notice, and does not make any commitment to update the information herein.

**© iSYSTEM. All rights reserved.**